

Article number: 12718000020500

Description: KLEE-coil 718 000 020.500
M2 St. steel 1.4305

Measures

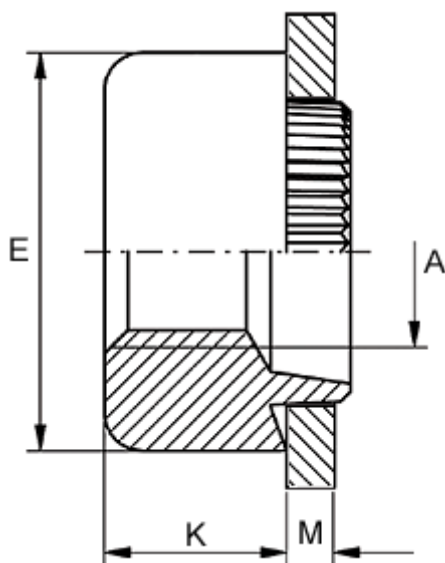

Female thread A	= M2
Height K	= 3.0
Outer diameter E	= 8.0
Plate thickness	= 5.0
Recommended bore diameter for extreme load	= 6.0
Recommended bore diameter for normal use	= 6.0